

# ***PRO Brake***

## ***Operating Instructions***



**Tapco**  **PRO14**<sup>™</sup>

**Tapco**  **PRO19**<sup>™</sup>

# PRO Brake System

**PRO™ Cut Off Gauge**  
Simplifies cutting.



**PRO™ Cut-Off**  
Quickly, safely, and easily makes factory quality cuts in coil stock, sheet metal, and vinyl siding right on your Brake.



**Brake Buddy™**  
Instant roll forming tool.

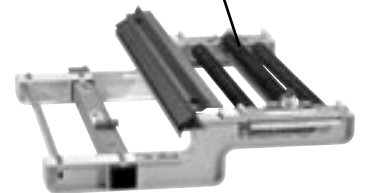

**Side-Winder™**  
Works in tandem with all PRO Series Brakes.



**Snap Stand™**  
Heavy Duty Transportable Support; sets up in seconds.



**Wheel Kit**  
Allows for easy transport of Snap Stand.

## PRO Accessories



Includes molded case.

### PRO™ Cut-Off

*Quickly, safely, and easily makes factory quality cuts in coil stock, sheet metal, and vinyl right on your Port-O-Bender.*

- Produces straight, square cuts. Reduces scrap and eliminates knifing damage to costly bending hinges.
- Lightweight aluminum construction built to last.
- Hardened and captured tool steel cutting knives for safety and durability.
- Eliminates use of dangerous utility knives and open blades.
- For use with all PRO Series' Port-O-Benders (1995 and after).
- Molded carrying case protects tool when not in use.



Saves time and labor in scoring and breaking off material.

### Side-Winder™

*Works in tandem with PRO Series Port-O-Benders to prevent coil damage.*

- Allows you to feed coil directly into the jaws of your PRO Brake. Eliminates the need for a separate layout table. Decreases damage from handling coil stock.
- Clamping bar speeds up production, helps decrease waste.
- Attaches in seconds to the end of the PRO series Port-O-Bender. (modification may be needed to use unit on heavy duty and MAX-I-MUM units)
- Holds up to 24" (61,0 cm) wide coil. Weighs only 24 lbs. (10,7 kg)
- Installs in seconds.



Keeps the coil at your side where you need it!

### Snap Stand™

*Heavy Duty Transportable Support for all PRO Series Brakes and ProTrax™ Multi-Angle Saw Table.*

- Works in conjunction with any portable siding brake.
- Variable height adjustment.
- Brake easily snaps and locks in place.
- Folds flat for easy storage.
- Durable aluminum for long life.
- Sets up in seconds.



### Optional Wheel Kit

- Allows for easy transport of Snap Stand
- Easy to attach
- 10" Pneumatic tires
- Steel hub



### Brake Buddy™

*Instant roll forming tool for portable brakes.*

- Quickly and easily forms brick mold trim and decorative ribs in .019 aluminum, PVC coated aluminum, and vinyl coated trim coil.
- Utilizes the edge of the material itself as a guide while the rib spacing is adjustable. Two different sets of rollers included.
- Enables you to offer added style and individuality to all your jobs.
- Includes molded carrying case.
- Optional Diamond Roller.



Fascia Rollers

Brick Mold Rollers



Simply turn adjustment handle until roller is at desired position for multiple ribs.



Includes molded storage case.

## Setting Up Your PRO Brake

### Hemming Handle Installation

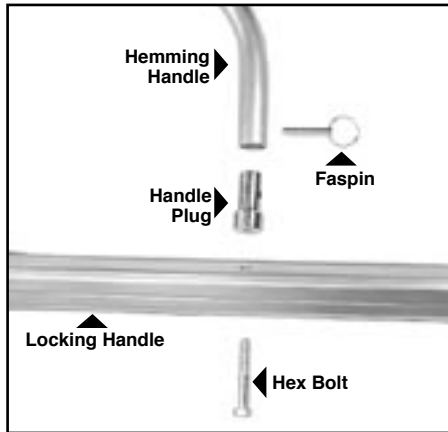

The Hemming Handle Assembly includes: (1) Hemming Handle, (2) Handle Plugs, (2) Faspins, (2) Hex Bolts.



Insert Hex Bolt through Locking Handle of your Port-O-Bender and into base of Hemming Handle as indicated using the 3/8" Hex Bolts provided. **HAND TIGHTEN ONLY.** Repeat for other side.



Attach the Hemming Handle over the Handle Plugs and secure them with Faspins. Now tighten the 3/8" Hex Bolts with a 9/16" wrench. Handle can be detached from now on by simply removing the Faspins.

### Lifting/Bending Handle Installation

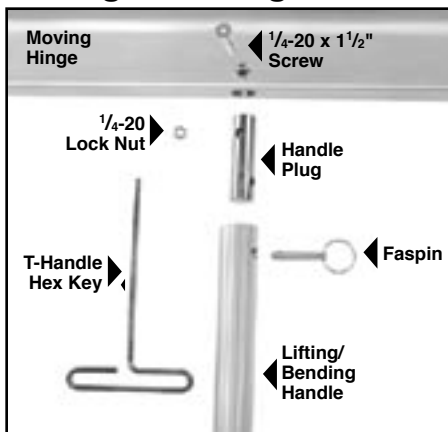

Remove the combination Lifting/Bending Handles from each end of the Port-O-Bender by removing the Faspins as shown.

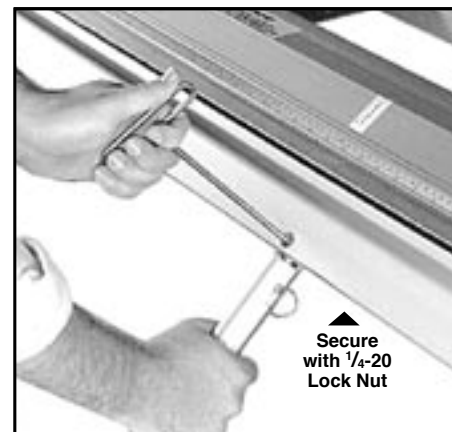

Insert Handle Assembly into hole in bottom of Moving Hinge. Align hole in hinge with Handle Plug and insert screw using T-Handle Hex Key as shown. Secure with 1/4-20 Lock Nut.



Repeat for other handle(s). To remove handles, simply release Faspins. Always use more than one handle when bending.

### Hinge Clip Installation

The Hinge Clip keeps the Moving Hinge in position for ease of aligning material. It can also prevent rippling of the coil during cut off operations.

To install Hinge Clip, locate predrilled hole on bottom center of Moving Hinge. Align holes in Clip and Hinge as shown and insert Phillips head screw provided.

Note: You must use hinge clip when using Pro Cut-Off.



## Using Your PRO Brake

### Basic Hemming and Folding



**1** Insert the material you wish to hem into your Port-O-Bender.



**2** Close and lock Bender on the material.



**3** Bend as far as you can go.



**4** Remove the material from the Port-O-Bender.

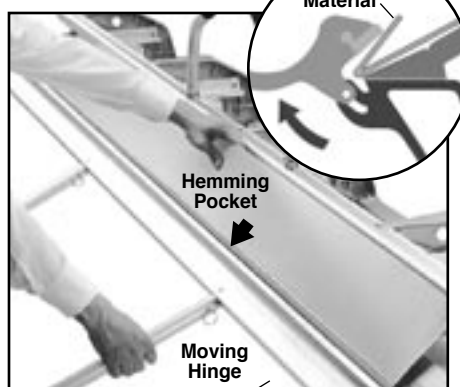

**5** Position the bent edge of the material in the Hemming Pocket on top of the Anvil.



**6** Lift the Bending Handles and compress the bend for a completed hem.

### Care and Maintenance of your Port-O-Bender®

Your Tapco Port-O-Bender® is virtually maintenance free and will provide you with years of reliable and trouble-free performance, however, there are a few basic necessities required to keep your Port-O-Bender® like new.

1. Clean the clamping surfaces each day before using. Use only clean shop towels that are free of dirt, oil and metal chips.
2. Do not use your bender around your saw table as the cuttings may get in between clamping surfaces and cause excessive wear or material scratching. Brush away any cuttings or filings that accumulate.
3. Transport your Port-O-Bender® in the unlocked position. You may transport it in the locked position if you clamp a piece of cardboard or vinyl siding between the clamping surfaces.
4. If your material is getting scratched, examine the Stainless Bending Edge, Base Hinge and Moving Hinge for roughness or burrs. Remove burrs with emery cloth or replace excessively worn parts. Optional Pro Cut-Off will help eliminate excessive wear to costly bending edge.
5. Use a lightweight spray oil along the moving pivot hinge after every 40 hours of use.

### Capacities

#### PRO 14/19 Bending Capacities

- Up to .030 soft aluminum
- Up to 28 ga. galvanized steel
- Up to 16 oz. copper sheet & coil

#### PRO 14 HD Bending Capacities

- Up to .040 soft aluminum
- Up to 26 ga.\* galvanized steel
- Up to 20 oz. copper sheet & coil

\* MAX-I-MUM II commercial model Port-O-Benders are available to bend up to 20 ga. galvanized steel.

## Snap Stand Set-Up

### STEP 1

To open each Leg Set, push in the snap button and move each leg outward to the working position. Figure 1A below shows the leg set as shipped while Figure 1B shows the leg set open (working position). Make sure that the snap button pops up to lock each leg.



Figure 1A



Snap Button locations when legs are closed.



Figure 1B



Snap Button locations when legs are open.

### STEP 2

Attach the Cross Braces to the Leg Sets. With the snap button of the Leg Set pointing to the outside, snap the Cross Braces into position. See Figures 2A and 2B below.

Note: Be sure the C-shape of the Cross Brace is mating the leg as shown in Figure 2C below.



Figure 2A

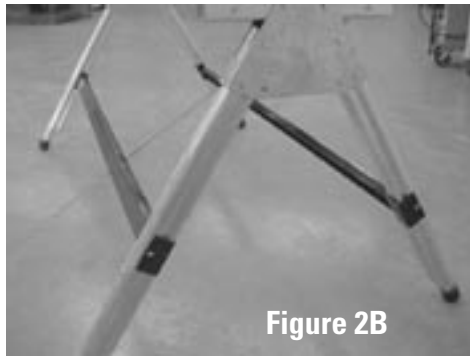

Figure 2B

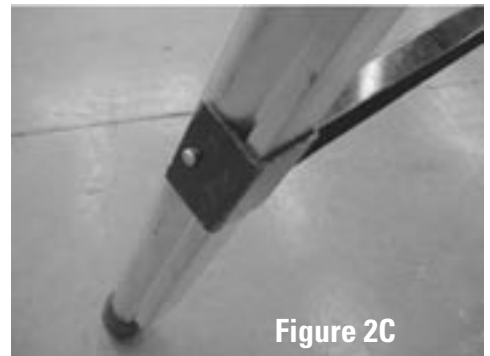

Figure 2C

## Attaching Optional Wheel Kit



### STEP 1

Insert the wheel assembly into the leg of the Snap Stand as shown in the figure above. Tap the bracket with a hammer to wedge it tightly into the leg. Repeat this process for the other leg.



Use one of these positions to stop the stand from rolling.

### STEP 2

To prohibit the stand from rolling on the wheels, lock the leg extensions into one of the bottom two locking positions. See figure above. If the leg extensions are in one of the other 3 positions, the wheels are in contact with the ground and are free to roll.

### STEP 3

To remove the wheel assembly, tap the bracket downward with a hammer to disengage.

## Installing Brake on Snap Stand

### STEP 1

Using the 1/4-20 bolts and lock washers provided, fasten the brake mounts to the Leg Set. Depending on which brake you're using, choose the correct holes as shown in the figure at right.

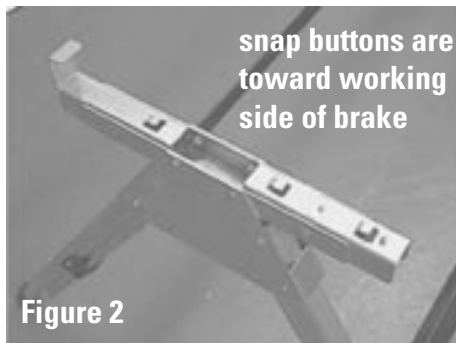
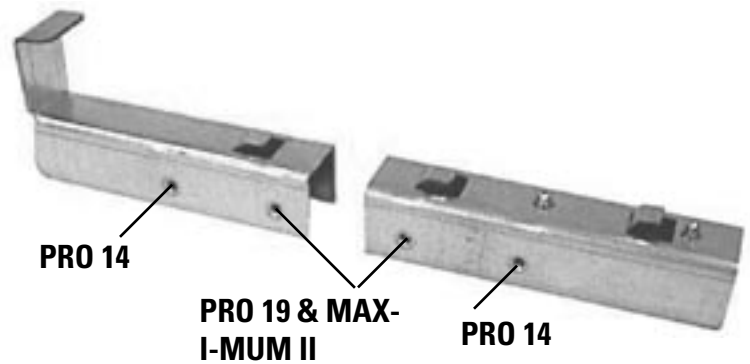

### STEP 2

The snap buttons will be towards the working side of the brake. Repeat Step 1 for the other Leg Set. Be sure both ends of the Snap Stand are going the same direction (with the snap buttons on the same side). See Figure 2 above.

### STEP 3

Place the brake on the assembled Snap Stand with the Back Rail of the brake clearing the adaptor hook as shown in Figures 3A and 3B above.



The snap button will be covered by the fixed hinge of the brake as in Figure 3C above.

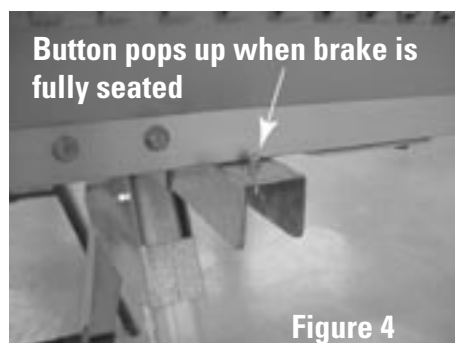

### STEP 4

Push the brake firmly rearward into the adaptor hooks. The snap buttons by the front clips will pop up and secure the brake on the Snap Stand. See Figure 4 above. The brake is now ready for use.

## Removing the Brake:

1. Removing the brake from the Snap Stand is essentially the opposite of attaching it to the stand.
2. Lifting the Moving Hinge, depress the snap button and pull the brake forward far enough to hold each snap button down.
3. Be sure the box rail is out of the Rear Clip. The brake can now be removed from the stand.
4. Reverse Steps 2 and 1 to disassemble the stand for transport.

# Common Shapes

NOTE: UP & DOWN refers to the clad, painted or FINISH SIDE of the material as it is placed into the Bender.

1. All Purpose Sill Trim

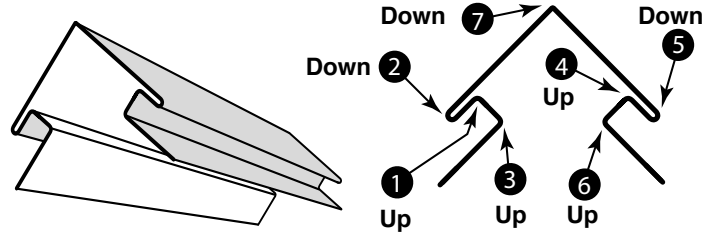
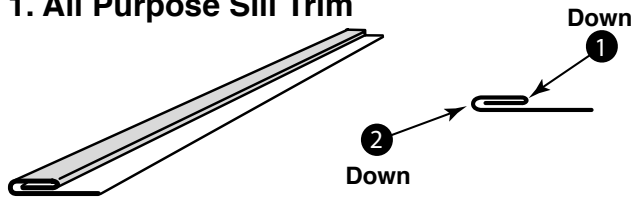

2. Fascia Trim

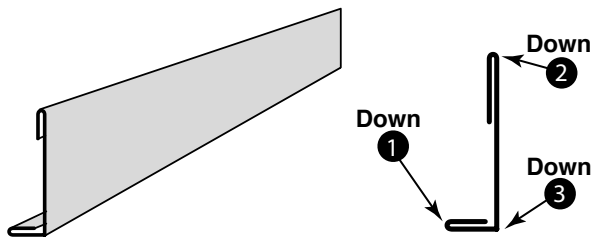

7. Counter Flashing

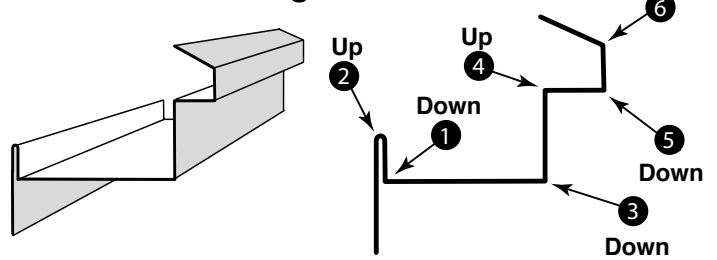

3. One Piece Soffit Mitre

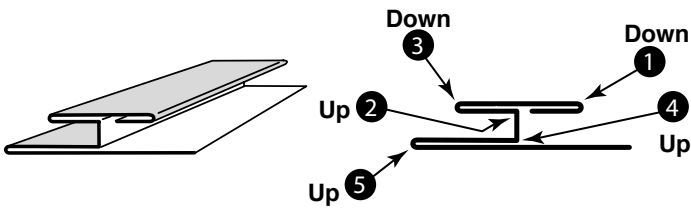

8. Brick Frieze

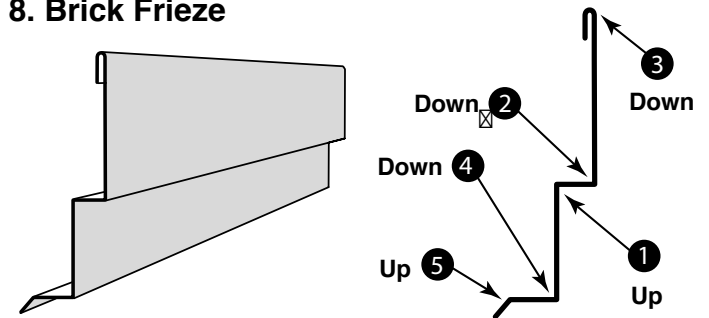

4. Rake Trim with "J" Channel

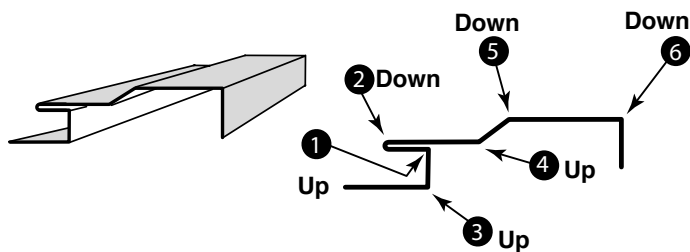

9. "F" Channel/Inside Corner

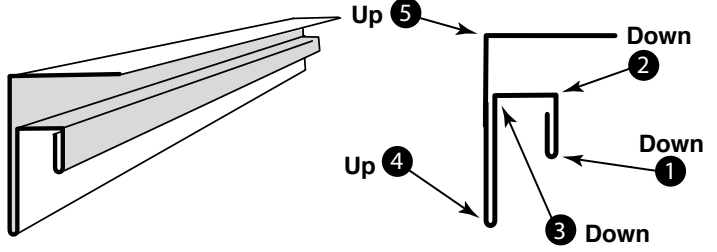

5. Soffit or Frieze Trim

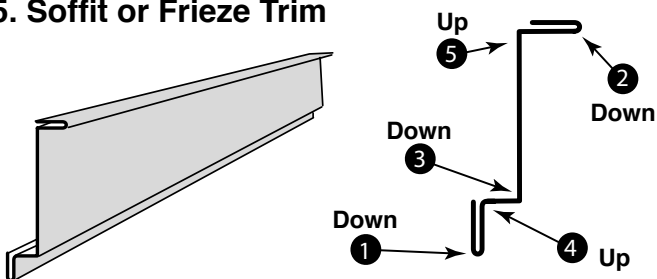

10. Window or Door Casing with "J" Channel

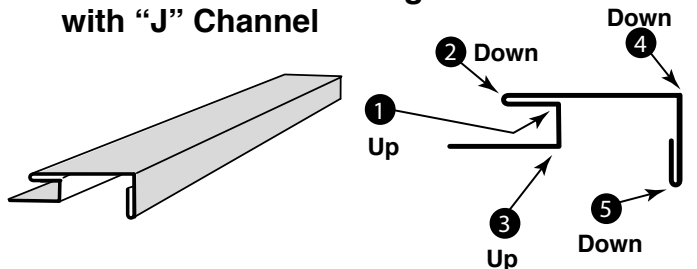

**TAPCO PRODUCTS COMPANY**

29797 Beck Road • Wixom, MI 48393-2834